



MDC 1200
Compatible

INSTRUCTION MANUAL

VHF TRANSCEIVER
IC-F50
UHF TRANSCEIVER
IC-F60

This device complies with Part 15 of the FCC rules. Operation is subject to the condition that this device does not cause harmful interference.

Icom Inc.



SAFETY TRAINING INFORMATION



WARNING

Your Icom radio generates RF electromagnetic energy during transmit mode. This radio is designed for and classified as “Occupational Use Only”, meaning it must be used only during the course of employment by individuals aware of the hazards, and the ways to minimize such hazards. This radio is NOT intended for use by the “General Population” in an uncontrolled environment.

This radio has been tested and complies with the FCC RF exposure limits for “Occupational Use Only”. In addition, your Icom radio complies with the following Standards and Guidelines with regard to RF energy and electromagnetic energy levels and evaluation of such levels for exposure to humans:

- FCC OET Bulletin 65 Edition 97-01 Supplement C, Evaluating Compliance with FCC Guidelines for Human Exposure to Radio Frequency Electromagnetic Fields.
- American National Standards Institute (C95.1-1992), IEEE Standard for Safety Levels with Respect to Human Exposure to Radio Frequency Electromagnetic Fields, 3 kHz to 300 GHz.
- American National Standards Institute (C95.3-1992), IEEE Recommended Practice for the Measurement of Potentially Hazardous Electromagnetic Fields— RF and Microwave.
- The following accessories are authorized for use with this product. Use of accessories other than those specified may result in RF exposure levels exceeding the FCC requirements for wireless RF exposure.; Belt Clip (MB-98), Rechargeable Li-Ion Battery Pack (BP-227), Alkaline Battery Case (BP-226) and Speaker-microphone (HM-138).



CAUTION

To ensure that your exposure to RF electromagnetic energy is within the FCC allowable limits for occupational use, always adhere to the following guidelines:

-
-
- **DO NOT** operate the radio without a proper antenna attached, as this may damaged the radio and may also cause you to exceed FCC RF exposure limits. A proper antenna is the antenna supplied with this radio by the manufacturer or antenna specifically authorized by the manufacturer for use with this radio.
 - **DO NOT** transmit for more than 50% of total radio use time (“50% duty cycle”). Transmitting more than 50% of the time can cause FCC RF exposure compliance requirements to be exceeded. The radio is transmitting when the “TX indicator” lights red. You can cause the radio to transmit by pressing the “PTT” switch.
 - **ALWAYS keep** the antenna at least 2.5 cm (1 inch) away from the body when transmitting and only use the Icom belt-clip which is listed on page vi when attaching the radio to your belt, etc., to ensure FCC RF exposure compliance requirements are not exceeded. To provide the recipients of your transmission the best sound quality, hold the antenna at least 5 cm (2 inches) from your mouth, and slightly off to one side.

The information listed above provides the user with the information needed to make him or her aware of RF exposure, and what to do to assure that this radio operates with the FCC RF exposure limits of this radio.

Electromagnetic Interference/Compatibility

During transmissions, your Icom radio generates RF energy that can possibly cause interference with other devices or systems. To avoid such interference, turn off the radio in areas where signs are posted to do so. **DO NOT** operate the transmitter in areas that are sensitive to electromagnetic radiation such as hospitals, aircraft, and blasting sites.

Occupational/Controlled Use

The radio transmitter is used in situations in which persons are exposed as consequence of their employment provided those persons are fully aware of the potential for exposure and can exercise control over their exposure.

FOREWORD

READ ALL INSTRUCTIONS carefully and completely before using the transceiver.

SAVE THIS INSTRUCTION MANUAL— This instruction manual contains important operating instructions for the IC-F50 VHF TRANSCEIVER and IC-F60 UHF TRANSCEIVER.

EXPLICIT DEFINITIONS

WORD	DEFINITION
⚠ WARNING	Personal injury, fire hazard or electric shock may occur.
CAUTION	Equipment damage may occur.
NOTE	If disregarded, inconvenience only. No risk of personal injury, fire or electric shock.

OPERATING NOTES

- When transmitting with a portable radio, hold the radio in a vertical position with its microphone 5 to 10 centimeters (2 to 4 inches) away from your mouth. Keep the antenna at least 2.5 centimeters (1 inch) from your head and body.
- If you wear a portable two-way radio on your body, ensure that the antenna is at least 2.5 centimeters (1 inch) from your body when transmitting.

Icom, Icom Inc. and the ICOM logo are registered trademarks of Icom Incorporated (Japan) in the United States, the United Kingdom, Germany, France, Spain, Russia and/or other countries.

PRECAUTION

⚠ **WARNING! NEVER** hold the transceiver so that the antenna is very close to, or touching exposed parts of the body, especially the face or eyes, while transmitting. The transceiver will perform best if the microphone is 5 to 10 cm (2 to 4 inches) away from the lips and the transceiver is vertical.

⚠ **WARNING! NEVER** operate the transceiver with a headset or other audio accessories at high volume levels.

CAUTION! NEVER short the terminals of the battery pack.

NEVER connect the transceiver to a power source other than the BP-226 or BP-227. Such a connection will ruin the transceiver.

DO NOT push the PTT when not actually desiring to transmit.

AVOID using or placing the transceiver in direct sunlight or in areas with temperatures below -30°C (-22°F) or above $+60^{\circ}\text{C}$ ($+140^{\circ}\text{F}$).

DO NOT modify the transceiver for any reason.

MAKE SURE the flexible antenna and battery pack are securely attached to the transceiver, and that the antenna and battery pack are dry before attachment. Exposing the inside of the transceiver to water will result in serious damage to the transceiver.

The use of non-Icom battery packs/chargers may impair transceiver performance and invalidate the warranty.

FCC caution:

Changes or modifications to this device, not expressly approved by Icom Inc., could void your authority to operate this transceiver under FCC regulations.

TABLE OF CONTENTS

SAFETY TRAINING INFORMATION	i
FOREWORD	iii
EXPLICIT DEFINITIONS	iii
OPERATING NOTES	iii
PRECAUTION	iv
TABLE OF CONTENTS	v
SUPPLIED ACCESSORIES	vi
1 ACCESSORIES	1-2
■ Accessory attachments	1
2 PANEL DESCRIPTION	3-11
■ Front, top and side panels	3
■ Function display	6
■ Programmable function keys	7
3 CONVENTIONAL OPERATION	12-18
■ Turning power ON	12
■ Channel selection	12
■ Call procedure	13
■ Receiving and transmitting	14
■ Scrambler function	17
■ User set mode	18
4 BIIS OPERATION	19-34
■ Default setting	19
■ Receiving a call	20
■ Transmitting a call	23
■ Receiving a message	26
■ Transmitting a status	29
■ Transmitting an SDM	30
■ Position data transmission	31
■ Printer connection	32
■ PC connection	32
■ Digital ANI	32
■ Auto emergency transmission	33
■ Stun function	33
■ BIIS indication	34
■ Priority A channel selection	34
5 MDC 1200 OPERATION	35-42
■ MDC 1200 system operation	35
■ Transmitting a call	36
■ Receiving a call	42

6 BATTERY CHARGING	43-52
■ Battery charging	43
■ Caution	44
■ Optional battery chargers	45
■ Optional battery case	51
7 SPEAKER-MICROPHONE	53-54
■ Optional HM-138 description	53
■ Attachment	54
8 OPTIONS	55-56

SUPPLIED ACCESSORIES

The following accessories are supplied: Qty.

- Flexible antenna1
- Battery pack1
- Jack cover1
- Belt clip1
- Function name stickers* (KEY-STICKER)1

*There are no names on the programmable function keys since the functions can be freely assigned to [P0] to [P3], [Red], [▼] and [▲] keys.

Attach the supplied function name stickers above the appropriate keys for easy recognition of that key's assigned function.



Versions of the IC-F50/F60 which display the "FM APPROVED" symbol as at left on the serial number seal, conform to intrinsically safe ratings of the FMRC (Factory Mutual Research Corporation).

- Intrinsically safe : Class I, II, III, Division 1,
Groups C, D, E, F, G
- Nonincendive : Class I, Division 2, Groups A, B, C, D
- Connected battery pack : BP-227FM

1 ACCESSORIES

■ Accessory attachments

◇ Flexible antenna

Connect the supplied flexible antenna to the antenna connector.

CAUTION!

- **NEVER HOLD** by the antenna when carrying the transceiver.
- Transmitting without an antenna may damage the transceiver.

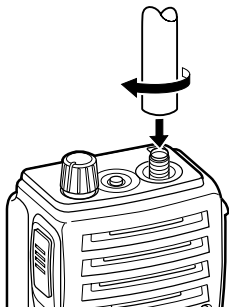

◇ Battery pack

To attach the battery pack:

Slide the battery pack on the back of the transceiver in the direction of the arrow (1), then lock it with the battery release button.

- Slide the battery pack until the battery release button makes a 'click' sound.

To release the battery pack:

Push the battery release button in the direction of the arrow (2) as shown below. The battery pack is then released.

NEVER release or attach the battery pack when the transceiver is wet or soiled. This may result water or dust getting into the transceiver/battery pack and may result in the transceiver being damaged.

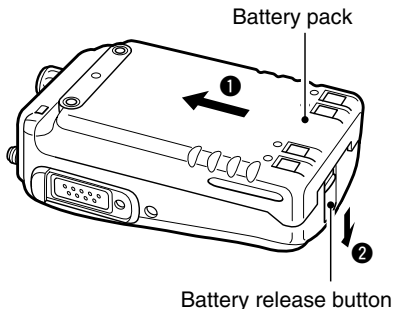

◆ Jack cover

Attach the jack cover when the optional speaker-microphone is not used.

To attach the jack cover:

- 1 Insert the jack cover into the [SP MIC] connector.
- 2 Tighten the screw.

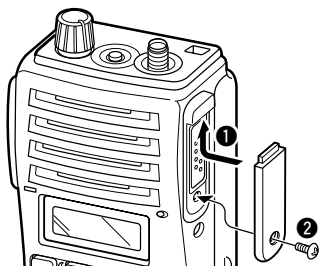

To detach the jack cover:

- 3 Unscrew the screw with a phillips screwdriver.
- 4 Detach the jack cover for the speaker-microphone connection.

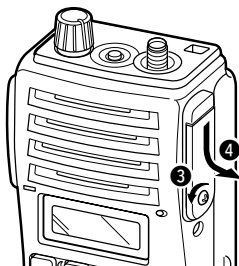

◆ Belt clip

Attach the belt clip to the back of the transceiver with the supplied screws.

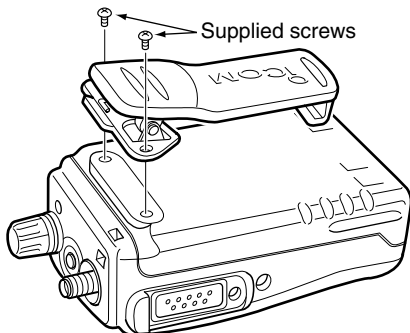

2 PANEL DESCRIPTION

■ Front, top and side panels

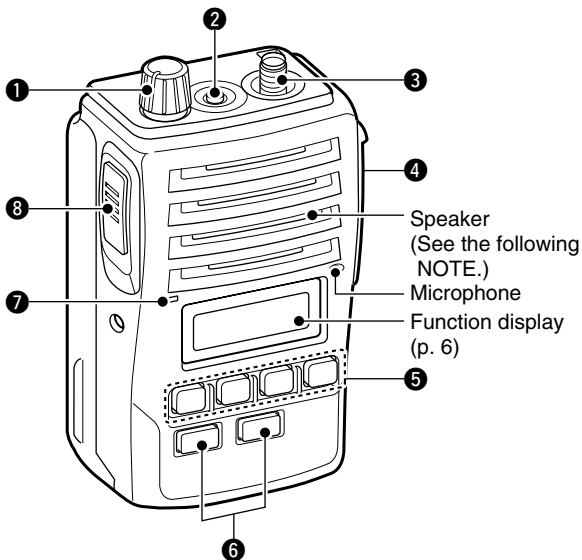

NOTE: If the speaker netting (for dust proofing) becomes wet, dry it with a hair drier (cool mode) etc. before operating the transceiver. Otherwise the audio may be difficult to hear for loss of the sound pressure.

① VOLUME CONTROL [VOL]

Turns power ON and adjusts the audio level.

② RED BUTTON

The desired function can be assigned by your dealer.

③ ANTENNA CONNECTOR

Connects the supplied antenna.

4 SPEAKER-MICROPHONE CONNECTOR [SP MIC]

Connects the optional speaker-microphone. (p. 54)

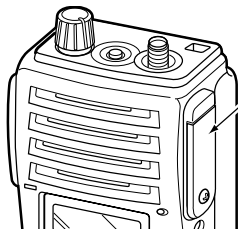

[SP MIC] jack cover

NOTE: KEEP the [SP MIC] jack cover attached to the transceiver when the speaker-microphone is not used.
(See p. 2 for details)

5 DEALER-PROGRAMMABLE KEYS [P0] to [P3]

The desired functions can be assigned independently by your dealer.

6 CH UP AND DOWN KEYS [▲]/[▼]

- ➔ During standby condition, push to select an operating channel.
- ➔ After pushing [TX Code CH Select], push to select a TX code channel.
- ➔ After pushing [DTMF Autodial], push to select a DTMF channel.
- ➔ After pushing and holding [Scan A Start/Stop]/[Scan B Start/Stop], push to select a scan group.
- ➔ After pushing [Digital], push to select a BIIS code, status number or SDM.

*Desired functions can be assigned independently by your dealer.

7 TRANSMIT/BUSY INDICATOR

Lights red while transmitting; lights green while receiving a signal, or when the squelch is open.

8 PTT SWITCH [PTT]

Push and hold to transmit; release to receive.

■ Function display

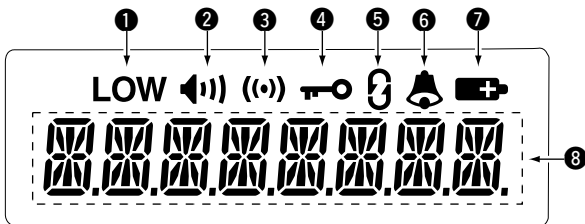

① OUTPUT POWER INDICATOR

Appears when Low 2 or Low 1 is selected.

② AUDIBLE INDICATOR

➤ Appears when the channel is in the 'audible' (unmute) condition.

➤ Appears when the specified 2/5-tone/BIIS code is received.

③ COMPANDER INDICATOR

Appears when the compander function is activated.

④ KEY LOCK INDICATOR

Appears during the key lock function ON.

⑤ SCRAMBLER INDICATOR

Appears when the voice scrambler function is activated.

⑥ BELL INDICATOR

Appears/blinks when the specific 2/5-tone/BIIS code is received, according to the programming.

⑦ BATTERY INDICATOR

Appears or blinks when the battery power decreases to a specified level.

⑧ ALPHANUMERIC DISPLAY

Displays the operating channel number, channel names, Set mode contents, DTMF numbers, etc.

■ Programmable function keys

The following functions can be assigned to [P0], [P1], [P2], [P3], [Red], [▼] and [▲] programmable function keys.

Consult your Icom dealer or system operator for details concerning your transceivers programming.

If the programmable function names are bracketed in the following explanations, the specific switch used to activate the function depends on programming.

CH UP AND DOWN KEYS

- Select an operating channel.
- Select a transmit code channel after pushing the [TX Code CH Select] keys.
- Select a DTMF channel after pushing the [DTMF Autodial] key.
- Select a scan group after pushing and holding the [Scan A Start/Stop]/[Scan B Start/Stop] keys.
- Select a BIIS code, status number or SDM after pushing the [Digital] key.
- Push to select the MDC menu after pushing [MDC CALL].
- Push to select the desired transceiver alias or message channel while in the transceiver alias or message channel selection mode.

BANK SELECT KEY

Push this key, then push [CH Up] or [CH Down] to select the desired bank.

SCAN START/STOP KEYS

- Push this key to start scanning; and push again to stop.
- Push and hold this key to indicate the scan group, then select the desired scan group using [CH Up]/[CH Down].

SCAN TAG KEY

Adds or deletes the selected channel to the scan group.

2 PANEL DESCRIPTION

PRIORITY CHANNEL KEYS

- Push to select Priority A or Priority B channel.
- Push and hold [Prio A (Rewrite)] to rewrite the Prio A channel.

MR-CH 1/2/3/4 KEYS

Select an operating channel directly.

MONITOR KEY

- Mute and release the CTCSS (DTCS) or 2-tone squelch mute. Open any squelch/deactivate any mute while pushing this key. (LMR operation only)
- Activates one of (or two of) the following functions on each channel independently: (PMR or BIIS PMR operation only)
 - Push and hold to un-mute the channel (audio is emitted; 'Audible' condition).
 - Push to mute the channel (sets to 'Inaudible' only).
 - Push to un-mute the channel (sets to 'Audible' only).
 - Push after the communication is finished to send a 'reset code'.

 **NOTE:** The un-mute condition ('Audible' condition) may automatically return to the mute condition ('Inaudible' condition) after a specified period.

LOCK KEY

Push and hold to electronically lock all programmable keys except the following:

[Call] (incl. Call A and Call B), [Moni(Audi)] and [Emergency] keys.

OUTPUT POWER SELECTION KEY

Select the transmit output power temporarily or permanently, depending on the pre-setting.

- Ask your dealer for the output power level for each selection.

C.TONE CHANNEL ENTER KEY

Select the continuous tone channel using [CH Up]/[CH Down] keys to change the tone frequency/code setting after pushing this key for permanent operation.

TALK AROUND KEY

Turn the talk around function ON and OFF.

- The talk around function equalizes the transmit frequency to the receive frequency for transceiver-to-transceiver communication.

WIDE/NARROW KEY

Push to toggle the IF bandwidth between wide and narrow.

- The wide passband width can be selected from 25.0 or 20.0 kHz using the CS-F50 CLONING SOFTWARE. (PMR or BIIS PMR operation only)
Ask your dealer for details.

DTMF AUTODIAL KEY

- Push to enter the DTMF channel selection mode. Then select the desired DTMF channel using [CH Up]/[CH Down] keys.
- After selecting the desired DTMF channel, push this key to transmit the DTMF code.

DTMF RE-DIAL KEY

Push to transmit the last-transmitted DTMF code.

CALL KEYS

Push to transmit a 2/5-tone/BIIS ID code.

- Call transmission is necessary before you call another station depending on your signalling system.
- The [Call A] and/or [Call B] keys may be available when your system employs selective 'Individual/Group' calls. Ask your dealer which call is assigned to each key.

2 PANEL DESCRIPTION

EMERGENCY KEYS

- Push and hold to transmit an emergency call.
- When [Emergency Single (Silent)] or [Emergency Repeat (Silent)] is pushed, an emergency call is transmitted without a beep emission and LCD indication change.
 - If you want to cancel the emergency call, push (or push and hold) the key again before transmitting the call.
 - The emergency call is transmitted one time only or repeatedly until receiving a control code depending on the pre-setting.

TX CODE ENTER KEY (PMR or BIIS PMR operation only)

Push to enter the direct ID code edit mode, for both 5-tone and MSK. Then set the desired digit using [CH Up]/[CH Down]/[TX Code CH Up]/[TX Code CH Down]. (p. 16)

TX CODE CHANNEL SELECT KEY

- Push to enter the direct ID code channel selection mode. Then set the desired channel using [CH Up]/[CH Down]/[TX Code CH Up]/[TX Code CH Down]. (p. 15)
- While in ID code channel selection mode, push for 1 sec. to enter the ID code edit mode for 5-tone and MSK. Then set the desired digit using [CH Up]/[CH Down]/[TX Code CH Up]/[TX Code CH Down]. (p. 16)

TX CODE CHANNEL UP/DOWN KEYS

Push to select a TX code channel directly.

ID MEMORY READ KEY (PMR or BIIS PMR operation only)

- Recalls detected ID codes.
 - Push this key, then push [CH Up]/[CH Down] for selection.
 - Up to 5 ID's are memorized.
- Push and hold to erase the selected memorized ID's.

VOICE SCRAMBLER FUNCTION

Push to toggle the voice scrambler function ON and OFF.

COMPANDER KEY

Push to toggle the compander function ON and OFF.

The compander function reduces noise components from the transmitting audio to provide clear communication.

USER SET MODE KEY

- Push and hold to enter user set mode.
 - During user set mode, push this key to select an item, and push [CH Up]/[CH Down] to change the value or condition.
- Push and hold this key again to exit user set mode.
 - User set mode is also available via the 'Power ON function'. Please refer to p. 18 also.

DIGITAL KEY (BIIS operation only)

- Push to select the call ID list, transmit message and standby condition. Toggles between queue channel and received message record indication after queue channel is selected.
- Push and hold to select queue channel indication.

STATUS UP/DOWN KEYS (BIIS operation only)

- While in the standby condition, push to display the transmit status indication and select a status number.
- When a received SDM is displayed, push to cancel the automatic scroll and scroll the message manually.
- When an SDM that contains more than 8 characters is displayed, push to scroll the message manually.

2 PANEL DESCRIPTION

MDC CALL KEY (MDC operation only)

➡ Push to enter the MDC menu selection mode. Then select the desired MDC menu from “SELCALL,” “MSG,” “STATUS,” “RADIOCHK” and “CALALERT” using [CH Up]/[CH Down]/[MDC Up]/[MDC Down].

After selection, push this key again to enter the transceiver alias or message channel selection mode.

➡ While in the transceiver alias or message channel selection mode, push to return to the MDC menu selection mode.

MDC UP AND DOWN KEYS (MDC operation only)

➡ Push to select the MDC menu after pushing [MDC CALL].

➡ Push to select the desired transceiver alias or message channel while in the transceiver alias or message channel selection mode.

MDC SELCALL KEY (MDC operation only)

Push to enter the transceiver alias selection mode.

• After the desired alias selection, push [PTT] to transmit a selective call.

MDC CALLALERT KEY (MDC operation only)

Push to enter the transceiver alias selection mode.

• After the desired alias selection, push [PTT] to transmit a call alert.

MDC EMG KEY (MDC operation only)

Push and hold for a specified period to transmit an MDC emergency call.

• If you want to cancel the emergency call, push (or push and hold) the key again before transmitting the call.

CONVENTIONAL OPERATION 3

■ Turning power ON

- ① Rotate [VOL] to turn power ON.
- ② If the transceiver is programmed for a start up passcode, input digit codes as directed by your dealer.
 - The keys in the table below can be used for password input:
 - The transceiver detects numbers in the same block as identical. Therefore “01234” and “56789” are the same.

KEY	P0	P1	P2	P3	▼ / ▲
NUMBER	0	1	2	3	4
	5	6	7	8	9

- ③ When the “PASSWORD” indication does not clear after inputting 4 digits, the input code number may be incorrect. Turn the power off and start over in this case.

■ Channel selection

Several types of channel selections are available. Methods may differ according to your system set up.

NON-BANK TYPE:

Push [▼]/[▲] to select the desired operating channel, in sequence; or, push one of the [MR-CH 1] to [MR-CH 4] keys to select a channel directly.

BANK-TYPE:

Push [Bank], then push [▼] or [▲] to select the desired bank.

AUTOMATIC SCAN TYPE:

Channel setting is not necessary for this type. When turning the power ON, the transceiver automatically starts scanning. Scanning stops when receiving a call.

■ Call procedure

When your system employs tone signalling (excluding CTCSS and DTCSS), the call procedure may be necessary prior to voice transmission. The tone signalling employed may be a selective calling system which allows you to call specific station(s) only and prevent unwanted stations from contacting you.

- ① Select the desired TX code channel or 2/5-tone code according to your System Operator's instructions.
 - This may not be necessary depending on programming.
 - Refer to pgs. 15, 16 for selection.
- ② Push the call switch (assigned to one of the dealer programmable switches: [P0], [P1], [P2], [P3], [Red], [▼] and [▲]).
- ③ After transmitting a 2/5-tone code, the remainder of your communication can be carried out in the normal fashion.

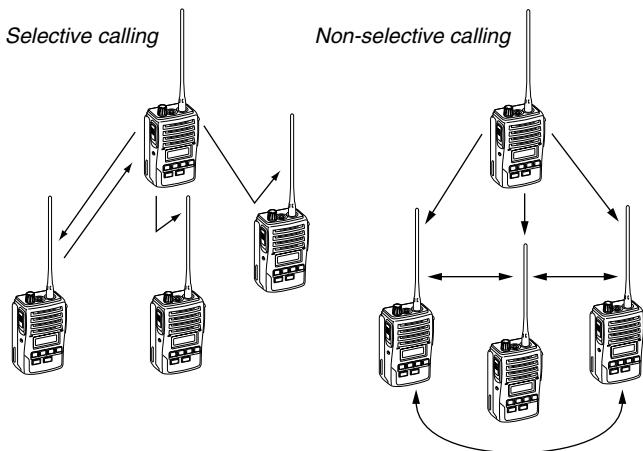

■ Receiving and transmitting

/// **NOTE:** Transmitting without an antenna may damage the transceiver. See p. 1 for antenna attachment.

3

Receiving:

- ① Rotate [VOL] to turn power ON.
- ② Push [▼] or [▲] to select a channel.
- ③ When receiving a call, adjust the audio output level to a comfortable listening level.

Transmitting:

Wait for the channel to become clear to avoid interference.

- ① While pushing and holding [PTT], speak into the microphone at a normal voice level.
 - When a tone signalling system is used, the call procedure described at left may be necessary.
- ② Release [PTT] to return to receive.

/// **IMPORTANT:** To maximize the readability of your signal;

1. Pause briefly after pushing [PTT].
2. Hold the microphone 5 to 10 cm (2 to 4 inches) from your mouth, then speak into the microphone at a normal voice level.

◇ **Transmitting notes**

• **Transmit inhibit function**

The transceiver has several inhibit functions which restrict transmission under the following conditions:

- The channel is in mute condition ('Inaudible' condition; "🔇" does not appear).
- Channel is busy.
- Un-matched (or matched) CTCSS is received.
- The selected channel is a 'receive only' channel.

• **Time-out timer**

After continuous transmission for the pre-programmed time period, the time-out timer is activated, causing the transceiver to stop transmitting.

• **Penalty timer**

Once the time-out timer is activated, transmission is further inhibited for a period determined by the penalty timer.

◇ **TX code channel selection**

If the transceiver has [TX Code CH Select] assigned to it, indication can be toggled between the operating channel number (or name) and TX code channel number (or name). When the TX code channel number (or name) is displayed, the [▼]/[▲] key selects the TX code channel.

TO SELECT A TX CHANNEL:

- ① Push [TX Code CH Select]— a TX code channel appears.
- ② Push [▼]/[▲] to select the desired TX code channel.
- ③ Push [Call] (or [PTT] during MSK operation) to transmit the selected TX code.
- ④ Push [TX Code CH Select] again to return to the operating channel number indication.

FOR TX CODE CHANNEL TYPE:

If the transceiver has a [TX Code CH Up] or [TX Code CH Down] key assignment, the programmed TX code channel can be selected directly.

◇ **TX code number edit** (PMR or BIIS PMR operation only)
If the transceiver has [TX Code CH Select] or [TX Code Enter] assigned to it, TX code contents can be edited within the allowable digits.

TO EDIT A TX CODE VIA [TX CODE CH SELECT] KEY:

- ① Push [TX Code CH Select] to enter the TX code channel selection mode.
 - Select the desired channel using [▼]/[▲] if necessary.
- ② Push [TX Code CH Select] for 1 sec. to enter the TX code edit mode.
- ③ Push [TX Code CH Select] to select the desired digit to be edited.
- ④ Set the desired digit using [▼]/[▲]/[TX Code CH Up]/[TX Code CH Down].
- ⑤ Push [TX Code CH Select] to set the digit. The editable digit will move to the right automatically.
- ⑥ Repeat ④ and ⑤ to input all allowable digits.
- ⑦ Push [Call] or [PTT] to transmit the selected TX code.

TO EDIT A TX CODE VIA [TX CODE ENTER] KEY:

- ① Select the desired TX code channel via [TX Code CH Up]/[TX Code CH Down].
- ② Push [TX Code Enter] to enter the TX code edit mode.
- ③ Push [TX Code Enter] to select the desired digit to be edited.
- ④ Set the desired digit using [▼]/[▲]/[TX Code CH Up]/[TX Code CH Down].
- ⑤ Push [TX Code Enter] to set the digit. The editable digit will move to the right automatically.
- ⑥ Repeat ④ and ⑤ to input all allowable digits.
- ⑦ Push [Call] or [PTT] to transmit the selected TX code.

3 CONVENTIONAL OPERATION

◇ DTMF transmission

If the transceiver has [DTMF Autodial] assigned to it, the automatic DTMF transmission function is available. Up to 8 DTMF channels are available.

TO SELECT A TX CODE:

- ① Push [DTMF Autodial]— a DTMF channel appears.
- ② Push [▼]/[▲] to select the desired DTMF channel.
- ③ Push [DTMF Autodial] to transmit the DTMF code in the selected DTMF channel.

■ Scrambler function

The voice scrambler function provides private communication between stations. The frequency inversion type is equipped to all versions, and some versions have the Rolling or Non-rolling type installed.

- ① Push [Scrambler] to turn the scrambler function ON.
- ② “” appears.
- ③ Push [Scrambler] again to turn the scrambler function OFF.

■ User set mode

User set mode is accessed at power ON and allows you to set seldom-changed settings. In this case you can “customize” transceiver operation to suit your preferences and operating style.

3

Entering the user set mode:

- ① While pushing and holding [▼] and [▲], rotate [VOL] to enter the user set mode at power ON.
- ② Push and hold [P0] to enter user set mode. Push [P0] momentarily to select the item.
Then push [▼] and [▲] to set the desired level/condition.

Available set mode functions:

- Backlight : ON, Auto or OFF
- Beep : ON or OFF
- SQL Level : 0 to 255
- AF Min level : ON or OFF
- Mic Gain : 1 to 5
- Battery Voltage : ON or OFF

- ③ Push and hold [P0] again to exit set mode.

User set mode is also available using a programmable key. Please refer to p. 11 [User Set Mode] section.

4 BIIS OPERATION

■ Default setting

The following functions are assigned to each programmable switch as the default. Ask your dealer for details.

- [P0]; Call : Push to transmit a 5-tone/BIIS call when the selected channel is a 5-tone or MSK channel, respectively.
- [P1]; Digital : Push to select the call list ID/transmit message, or to display the receive message record for selection.
- [P3]; Moni(Audi) : Push this key after the communication to send a "clear down" signal during MSK channel operation.
- [▼]/[▲]; CH Down/Up : While in the standby condition, selects the operating channel.
After pushing [Digital] or [TX Code CH Select], selects call list or TX code channel, respectively.
- [P2]/[Red]; Null : No function is assigned.

■ Receiving a call

◇ Individual call

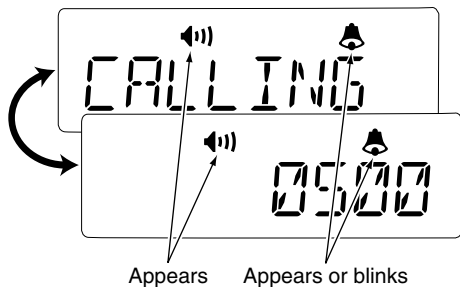

- ① When an individual call is received;
 - Beeps sound.
 - “🔊” appears and the mute is released.
 - The programmed text message (e.g. “CALLING”) and the calling station ID (or text) is displayed alternately, depending on the setting.
 - “🔔” appears or blinks depending on the setting.





- ② Push and hold [PTT], then speak into the microphone at a normal voice level.
 - Transmit/Busy indicator lights red.
- ③ Release [PTT] to return to receive.
 - Transmit/Busy indicator lights green while receiving a signal.
- ④ To finish the conversation, push [P3] (Moni(Audi)) to send the “Clear down” signal.
 - Either station can send a clear down signal.
 - “CLR DOWN” is displayed for 2 sec. (approx.).
 - “🔊” disappears and the transceiver returns to the standby condition.

4 BIIS OPERATION

◇ Group call

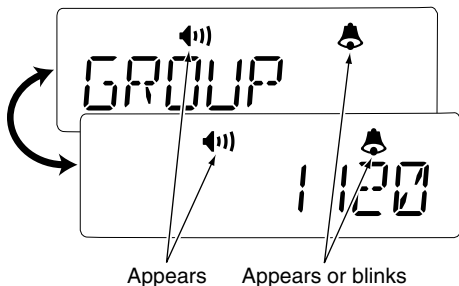
- ① When a group call is received;
 - Beeps sound.
 - “” appears and the mute is released.
 - The programmed text message (e.g. “GROUP”) and the calling station ID (or text) is displayed alternately, depending on the setting.
 - “” appears or blinks depending on the setting.



- ② Push and hold [PTT], then speak into the microphone at a normal voice level.
 - ∕∕ **NOTE:** Only one station is permitted to speak.
 - Transmit/Busy indicator lights red.
- ③ Release [PTT] to return to receive.
 - Transmit/Busy indicator lights green while receiving a signal.
- ④ To finish the conversation, push [P3] (Moni(Audi)) to send the “Clear down” signal.
 - Either station can send a clear down signal.
 - “CLR DOWN” is displayed for 2 sec. (approx.)
 - “” disappears and the transceiver returns to the standby condition.

◇ Displaying the received call record — Queue indication

The transceiver memorizes the calling station IDs for record. Up to 3 calls can be memorized, and the oldest call record is erased when a 4th call is received. However, once the transceiver is powered OFF, the all records are cleared.

- ① Push [P1] (Digital) for 1 sec.
 - Displays following indication.

When a record is available



--QUEUE1--

When no record is available



NO QUEUE

- ② Push [▼]/[▲] to select the desired call.
- ③ Push [P1] (Digital) for 1 sec. again to return to the standby condition.
 - When no operation is performed for 30 sec., the transceiver returns to the standby condition automatically.

■ Transmitting a call

Total of a 3 ways for code selection are available—selecting the call code from memory, entering the call code from the keypad and calling back from the queue channel record.

◇ Using call memory

- ① While in the standby condition, push [P1] (Digital) to enter the call code memory channel selection mode.

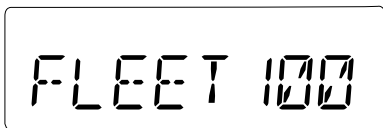

Call code text is displayed.

- ② Push [▼]/[▲] to select the desired call code.
- ③ Push [P0] (Call) or [PTT]* to call.

*PTT call can be made only when PTT call capability is permitted.

NOTE: When no answer back is received, the transceiver repeats the call 3 times (default) automatically, and "WAIT" is displayed during each call. However, an error beep sounds and "FAILED" is displayed when no answer back is received after the calls.

- ④ Push [PTT] to transmit; release to receive.
- ⑤ Push [P3] (Moni(Audi)) to send the "Clear down" signal.

◇ Calling back from the queue channel

- ① While in the standby condition, push [P1] (Digital) for 1 sec. to enter queue memory channel selection mode.
- ② Push [▼]/[▲] to select the desired record.



--QUEUE 1--

- ③ Push [P0] (Call) or [PTT]* to call.
*PTT call can be made only when PTT call capability is permitted.

NOTE: When no answer back is received, the transceiver repeats the call 3 times (default) automatically, and "WAIT" is displayed during each call. However, an error beep sounds and "FAILED" is displayed when no answer back is received after the calls.

- ④ Push [PTT] to transmit; release to receive.
- ⑤ Push [P3] (Moni(Audi)) to send the "Clear down" signal.

4 BIIS OPERATION

◆ Direct code entry

- ① While in the standby condition, push [TX Code Enter] to enter the TX code edit mode.
 - Editable code digit blinks.

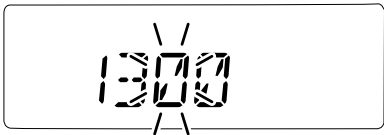

- ② Push [TX Code Enter] to select the desired digit to be edited.
 - Editable digit differs according to the setting.
- ③ Set the desired digit using [▼]/[▲]/[TX Code CH Up]/[TX Code CH Down].
- ④ Push [TX Code Enter] to set the digit. The editable digit will move to the right automatically.
- ⑤ Repeat ③ and ④ to input all allowable digits.
- ⑥ Push [P0] (Call) or [PTT]* to call.

*PTT call can be made only when PTT call capability is permitted.

NOTE: When no answer back is received, the transceiver repeats the call 3 times (default) automatically, and “WAIT” is displayed during each call. However, an error beep sounds and “FRIED” is displayed when no answer back is received after the calls.

- ⑦ Push [PTT] to transmit; release to receive.
- ⑧ Push [P3] (Moni(Audi)) to send the “Clear down” signal.

For your information

When the “UpDate” setting for the call code is enabled, the set code is overwritten into the call code memory.

■ Receiving a message

◇ Receiving a status message

- ① When a status message is received;
- Beeps sound.
 - The calling station ID (or text) and the status message is displayed alternately, depending on the setting.

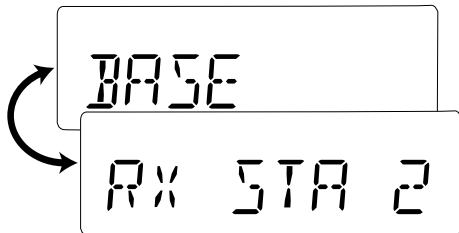

- ② Push [P3] (Moni(Audi)) to return to the standby condition.

NOTE: Only the calling station ID (or text) is displayed (no message is displayed alternately) when the scroll timer is set to "OFF". In this case, push [Status Up]/[Status Down] to display the status message manually.

4 BIIS OPERATION

◆ Receiving an SDM

- ① When an SDM is received;
 - Beeps sound.
 - The calling station ID (or text) and the SDM is displayed alternately, depending on the setting.

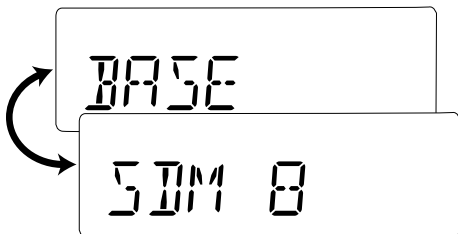

- ② When the received SDM includes more than 8 characters, the message scrolls automatically, when the automatic scroll function is activated.
 - Push [Status Up]/[Status Down] to scroll the message manually.
- ③ Push [P3] (Moni(Audi)) to return to the standby condition.

◇ Received message selection

The transceiver memorizes the received messages for record. Up to 6 messages for status and SDM, or 95 character SDM's can be memorized. The oldest message is erased when the 7th message is received. However, once the transceiver is powered OFF, all messages are cleared.

- ① Push [P1] (Digital) for 1 sec.
 - Displays queue memory.
- ② Push [P1] (Digital) momentarily.
 - Displays message memory.

When a message is available

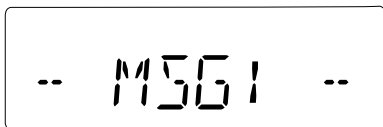

When no message is available

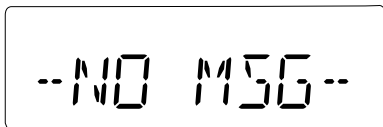

- ③ Push [▼]/[▲] to select the desired message.
 - When selecting the SDM that includes more than 8 characters, the message scrolls automatically, when the automatic scroll function is activated.
 - Push [Status Up]/[Status Down] to scroll the message manually.
- ④ Push [P1] (Digital) for 1 sec. again to return to the standby condition.
 - When no operation is performed for 30 sec., the transceiver returns to the standby condition automatically.

■ Transmitting a status

◇ General

The status message can be selected with the programmed text, and the message text is also displayed on the function display of the called station.

Up to 24 status types (1 to 24) are available, and the status messages 22 and 24 have designated meanings.

Status 22: Emergency*

Status 24: GPS request

*The status 22 can also be used as a normal status message by disabling the designated meaning. However, the status 24 is fixed.

The status call can be sent with both individual and group calls.

◇ Transmitting a status

- ① While in the standby condition, push [P1] (Digital), then push [▼]/[▲] to select the desired station/group code.
- ② Push [P1] (Digital) again, then push [▼]/[▲] to select the desired status message.

Or, you can select the desired status message using [Status Up]/[Status Down] key directly.

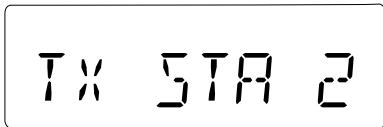

Status message is displayed.

- ③ Push [P0] (Call) or [PTT]* to transmit the status message to the selected station/group.

*PTT call can be made only when PTT call capability is permitted.

- 2 beeps will sound and the transceiver returns to the standby condition automatically when the transmission is successful.

■ Transmitting an SDM

◇ General

The short data message, SDM, can be sent to an individual station or group stations. Also, 8 SDM memory channels are available and the messages can be edited via PC programming.

4

◇ Transmitting an SDM

- ① While in the standby condition, push [P1] (Digital), then push [▼]/[▲] to select the desired station/group code.
- ② Push [P1] (Digital) again, then push [▼]/[▲] to select the desired SDM.

Or, you can select the desired SDM using [Status Up]/[Status Down] key directly.



SDM 8

SDM is displayed.

- ③ Push [P0] (Call) or [PTT]* to transmit the SDM to the selected station/group.
 - *PTT call can be made only when PTT call capability is permitted.
 - 2 beeps will sound and the transceiver returns to the standby condition automatically when the transmission is successful.

■ Position data transmission

When the optional OPC-966 INTERFACE CABLE and a GPS receiver is connected to the transceiver, the position (longitude and latitude) data can be transmitted automatically.

Ask your dealer or system operator for connection details.

The position data is transmitted when;

- Status 24 message is received
 - *When the status 24 message, GPS request, is received.
- Fully automatic
 - When automatic position transmission is enabled, send the position data according to 'Time Marker' and 'Interval Timer' settings.
- PTT is released
 - When 'Send with Logoff' is enabled.
 - Set the "Log-In/Off" item as "L-OFF".
- After sending a status message
 - When 'Send with Status' is enabled.
- After sending an SDM
 - When 'Send with SDM' is enabled.
- After sending status 22 (Emergency)
 - When 'Send with Emergency' is enabled.

■ Printer connection

When the optional OPC-966 INTERFACE CABLE is connected to the transceiver, a printer can be connected to print out the received SDM content and the ID of the station who sent the message.

Ask your dealer or system operator for connection details.

4

■ PC connection

When the optional OPC-966 INTERFACE CABLE is connected to the transceiver, a PC can be connected to provide remote control, data reception, etc.

Ask your dealer or system operator for connection details.

■ Digital ANI

The own ID can be transmitted each time the PTT is pushed (log-in) or released (log-off) during individual or group call communications. By receiving the ANI, the communication log can be recorded when using a PC dispatch application.

In addition, when using the ANI with log-in, the PTT side tone function can be used to inform you that the ID is sent and voice communication can be performed.

■ Auto emergency transmission

When [Emergency Single (Silent)] or [Emergency Repeat (Silent)] is pushed, an emergency signal is automatically transmitted for the specified time period.

The status 22 (Emergency) is sent to the selected ID station, and the position data is transmitted after the emergency signal when a GPS receiver is connected to the transceiver.

The emergency transmission is performed on the emergency channel, however, when no emergency channel is specified, the signal is transmitted on the previously selected channel.

There is no change in the function display or beep emission during automatic emergency transmission.

■ Stun function

When the specified ID, set as a killer ID, is received, the stun function is activated.

When the killer ID is received, the transceiver switches to the passcode required condition. Entering of the passcode via the keypad is necessary to operate the transceiver again in this case.

■ BIIS indication

The following indications are available for the BIIS operation on an MSK channel.

- CONNECT* : Individual/group call is successful.
- OK* : Message (status or SDM) transmission is successful.
- FAILED* : No answer back is received.
- WAIT* : Appears during retry of the call (2nd call).
- CLR DOWN* : End the communication.
- BUSY* : Operating channel is in the busy condition.

4

■ Priority A channel selection

When one of the following operations is performed, the transceiver selects the Priority A channel automatically.

Priority A is selected when;

- Clear down signal is received/transmitted
 - Set the "Move to PrioA CH" item as "Clear Down".
- Turning the power ON
 - The Priority A channel is selected each time the transceiver power is turned ON.
- Status call
 - The Priority A channel is selected when transmitting a status call.
 - Enable the "Send Status on PrioA CH" item in the MSK configuration.

5 MDC 1200 OPERATION

■ MDC 1200 system operation

The MDC 1200 signaling system enhances your transceiver's capabilities. It allows PTT ID*, Selective Calling, Call Alert, Radio Check, Messaging and Emergency signaling. Also, the dispatcher can stun and revive transceivers on the system.

An additional feature of MDC 1200 found in Icom transceivers is called aliasing. Each transceiver on the system has a unique ID number. Aliasing allows the substitution of an alphanumeric name for this ID number. For transmit, you can use this alias to select a transceiver to call. For receive, the alias of the calling station is displayed instead of the ID.

Please note that your dealer has set one of the programmable keys (P0, P1, P2, or P3) for MDC 1200 operation.

*When [PTT] is pushed or released, self ID is transmitted.

■ Transmitting a call

◇ Transmitting a Selective Call

Selective calling allows you to make a call to a specific station or to a particular group. Other MDC 1200 transceivers on the channel will not receive a selective call that does not match their station or group ID's.

- ① Push [MDC Call] to enter the MDC menu selection mode.
 - Or push [MDC Selcall] to enter the transceiver alias selection mode. In this case, skip step ②.



SELCALL

- ② Push [MDC Call] again to enter the transceiver alias selection mode.
- ③ Select the desired alias using [CH Up], [CH Down], [MDC Up] or [MDC Down].
- ④ Push and hold [PTT] to transmit the selective call to the selected station, then speak into the microphone.
- ⑤ Release [PTT] to receive.

◆ Transmitting a Call Alert

Call Alert allows you to notify another user who may be away from the transceiver that you want to talk.

- ① Push [MDC Call] to enter the MDC menu selection mode.
 - Or push [MDC CallAlert] to enter the transceiver alias selection mode. In this case, skip steps ② and ③.
- ② Select “CALALERT” using [CH Up], [CH Down], [MDC Up] or [MDC Down].

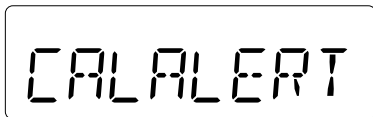

- ③ Push [MDC Call] again to enter the transceiver alias selection mode.
- ④ Select the desired alias using [CH Up], [CH Down], [MDC Up] or [MDC Down].
- ⑤ Push [PTT] to transmit the call alert to the selected station.
 - “CA CALL” is displayed.
- ⑥ Release [PTT].
 - “CA OK” is displayed if the targeted station received the alert.
 - “CA FAIL” is displayed if the targeted station does not send an acknowledgement.
- ⑦ After a specified time period has passed, the transceiver will return to receive.

◆ Transmitting a Radio Check Call

Radio check call allows you to determine whether another transceiver is turned on, within range and on channel without requiring any action from the targeted station user.

- ① Push [MDC Call] to enter the MDC menu selection mode.
- ② Select "RADIOCHK" using [CH Up], [CH Down], [MDC Up] or [MDC Down].

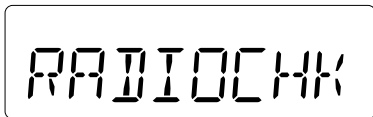

- ③ Push [MDC Call] again to enter the transceiver alias selection mode.
- ④ Select the desired alias using [CH Up], [CH Down], [MDC Up] or [MDC Down].
- ⑤ Push [PTT] to transmit the radio check call to the selected station.
 - "RDO CHK" is displayed.
- ⑥ Release [PTT].
 - "CHK ACK" is displayed if the targeted station is turned ON, on channel and within range.
 - "CHK FAIL" is displayed if the targeted station does not send an acknowledgement.
- ⑦ After a specified time period has passed, the transceiver will return to receive.

◆ Transmitting a Status Message

Status Messaging allows you to send a pre-programmed status message to the dispatcher. There are 16 status codes that can be sent. In addition, the dispatcher can send an MDC 1200 signal that causes the transceiver to automatically transmit its current status.

- ① Push [MDC Call] to enter the MDC menu selection mode.
- ② Select "STATUS" using [CH Up], [CH Down], [MDC Up] or [MDC Down].

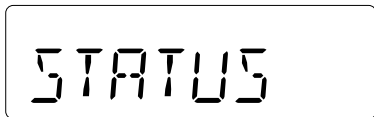

- ③ Push [MDC Call] again to enter the status message selection mode.

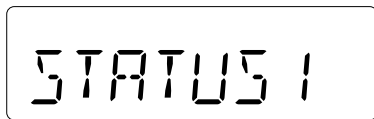

Pre-programmed status message is displayed.

- ④ Select the desired status message using [CH Up], [CH Down], [MDC Up] or [MDC Down].
- ⑤ Push [PTT] to transmit the status message to the dispatcher.
 - "STAT TX" is displayed.
- ⑥ Release [PTT].
 - "STAT OK" is displayed.
 - "STA FAIL" is displayed if there is no acknowledgment from the dispatcher.
- ⑦ After a specified time period has passed, the transceiver will return to receive.

◆ Transmitting a Message

The transceiver can send a pre-programmed message to the dispatcher. There are 16 messages that can be sent on a channel.

- ① Push [MDC Call] to enter the MDC menu selection mode.
- ② Select “MSG” using [CH Up], [CH Down], [MDC Up] or [MDC Down].

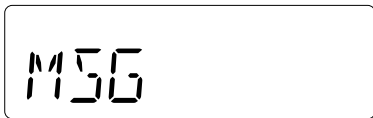

- ③ Push [MDC Call] again to enter the pre-programmed message selection mode.

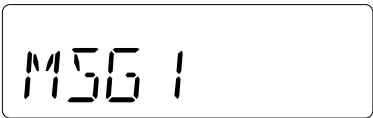

Pre-programmed message is displayed.

- ④ Select the desired message using [CH Up], [CH Down], [MDC Up] or [MDC Down].
- ⑤ Push [PTT] to transmit the message to the dispatcher.
 - “MSG TX” is displayed.
- ⑥ Release [PTT].
 - “MSG OK” is displayed.
 - “MSG FAIL” is displayed if there is no acknowledgment from the dispatcher.
- ⑦ After a specified time period has passed, the transceiver will return to receive.

◆ Emergency Calls

The MDC 1200 Emergency feature can be accessed using the [MDC Emg] key (p. 11). The transceiver will repeatedly send an Emergency MDC 1200 command to the dispatcher for a programmed length of time until it receives an acknowledgement signal.

The emergency call can be transmitted without a beep emission and LCD indication change depends on the setting.

With MDC 1200 Emergency, the transceiver can also be programmed to keep the microphone open during an emergency call, allowing monitoring of the situation.

Ask your dealer for details.

◆ Stun and Revive

The dispatcher can send MDC 1200 signals that will stun or revive your transceiver. If a Stun command is received that matches your station ID, the transceiver will display “SORRY” and you can not receive or transmit. When a Revive command is received that matches your station ID, normal operation is restored.

■ Receiving a call

◇ Receiving a Selective Call

- ① When an individual call is received;
 - Beeps sound, “

- ② Push and hold [PTT] and speak into the microphone.
- ③ Release [PTT] to receive a response.

◇ Receiving a Call Alert

- ① When a Call Alert is received;
 - Beeps sound and “

- ② Push and hold [PTT] and speak into the microphone.
- ③ Release [PTT] to receive a response.

6 BATTERY CHARGING

■ Battery charging

Prior to using the transceiver for the first time, the battery pack must be fully charged for optimum life and operation.

/// **CAUTION:** To avoid damage to the transceiver, turn it OFF while charging.

- Recommended temperature range for charging:
 - +10°C to +40°C (+50°F to +104°F)
 - The Li-Ion battery functions within -20°C to +60°C (-4°F to +140°F)
- Use the specified chargers (BC-152, BC-119N and BC-121N). **NEVER** use another manufacturer's charger.
- Use the optional AC adapter (BC-147A/E) for the BC-152.
- **NEVER** use another manufacturer's AC adapter.

Recommendation:

Charge the supplied battery pack for a maximum of up to 10 hours. Li-Ion batteries are different from Ni-Cd batteries in that it is not necessary to completely charge and discharge them to prolong the battery life. Therefore, charging the battery in intervals, and not for extended periods is recommended.

■ Caution

CAUTION! NEVER insert battery pack/transceiver (with the battery pack attached) with wet or soiled into the charger. This may result in corrosion of the charger terminals or damage to the charger. The charger is not waterproof and water can easily get into it.

NEVER incinerate used battery packs. Internal battery gas may cause an explosion.

NEVER immerse the battery pack in water. If the battery pack becomes wet, be sure to wipe it dry immediately (particularly the battery terminals) **BEFORE** attaching it to the transceiver. Otherwise, the terminals will become corroded, or cause connection failure, etc.

NEVER short the terminals of the battery pack. Also, current may flow into nearby metal objects, such as a necklace, etc. Therefore, be careful when carrying with, or placing near metal objects, carrying in handbags, etc.

AVOID leaving the battery pack in a fully charged, or completely discharged condition for long time. It causes shorter battery life. In case of leaving the battery pack unused for a long time, it must be kept safely after discharge, or use the battery until the battery indicator appears, then remove it from the transceiver.

If your battery pack seems to have no capacity even after being charged, fully charge the battery pack again. If the battery pack still does not retain a charge (or very little), a new battery pack must be purchased.

■ Optional battery chargers

◇ Regular charging with the BC-152

- ① Attach the BC-152 to a flat surface, such as a desk, if desired.
- ② Connect the AC adapter (BC-147A/E*) as shown below.
*Depending on version.
- ③ Insert the battery pack with/without the transceiver into the charger.
 - The charge indicator lights green.
- ④ Charge the battery pack approx. 9–10 hours, depending on the remaining power condition.
 - The charge indicator goes off when charging is complete.

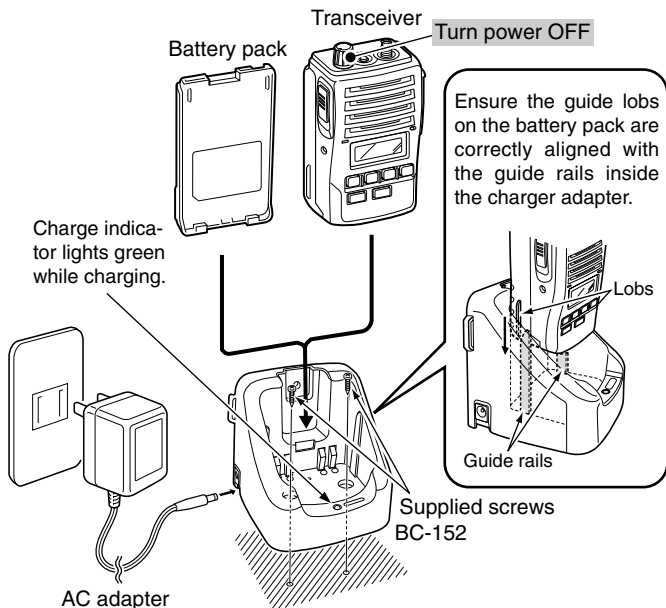

◇ For your convenience

Eyelet →
USE a rubber band to
secure the transceiver
while charging, if
desired.

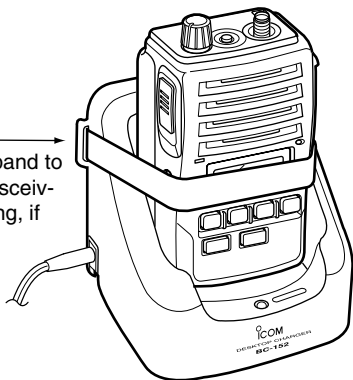

6

6 BATTERY CHARGING

◆ AD-100 installation

- ① Install the AD-100 desktop charger adapter into the holder space of the BC-119N/121N.

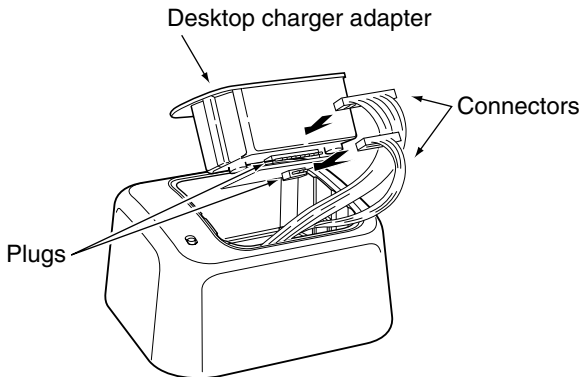

- ② Connect the plugs of the BC-119N/121N to the AD-100 with the connector, then install the adapter into the charger with the supplied screws.

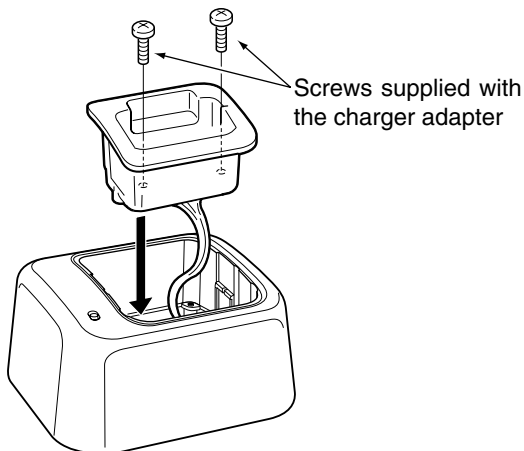

6 BATTERY CHARGING

◇ Rapid charging with the BC-119N+AD-100

The optional BC-119N provides rapid charging of optional Li-Ion battery packs.

The following are additionally required:

- One AD-100 (purchase separately).
- An AC adapter (may be supplied with BC-119N depending on version) or the DC power cable (OPC-515L/CP-17L).

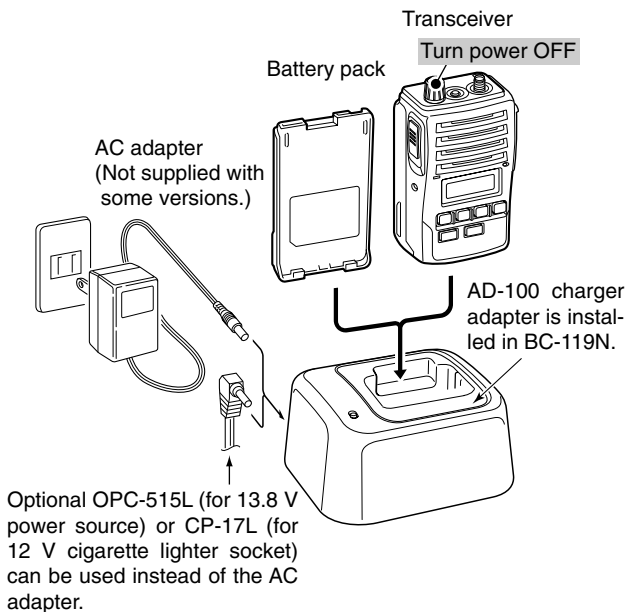

◇ Rapid charging with the BC-121N+AD-100

The optional BC-121N allows up to 6 battery packs to be charged simultaneously. The following are additionally required.

- Six AD-100.
- An AC adapter (BC-157) or the DC power cable (OPC-656)

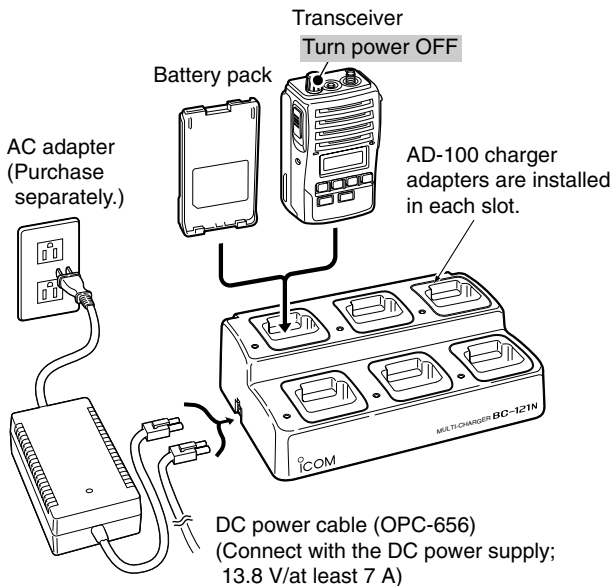

■ Optional battery case

When using the optional battery case, install 5 × AA (R6) size alkaline batteries as illustrated at right. The BP-226 meets JIS waterproof specification grade 4.

- ① Hook your finger under the latch, and open the cover in the direction of the arrow (❶). (Fig.1)
- ② Then, install 5 × AA (R6) size alkaline batteries. (Fig.2)
 - Install the alkaline batteries only.
 - Be sure to observe the correct polarity.
 - Do not pin the ribbon under the batteries.
- ③ Close the cover by fitting in the direction of the arrow (❷) first, then check the latch is in place (❸). (Fig.1)
 - Be sure the gasket and the ribbon are set correctly, and do not protrude from the battery case. (Fig.3)

/// CAUTION:

- When installing batteries, make sure they are all the same brand, type and capacity. Also, do not mix new and old batteries together.
- Keep battery contacts clean. It's a good idea to clean battery terminals once a week.

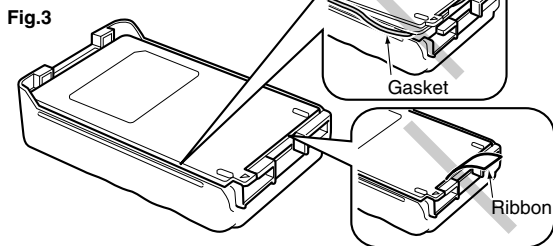
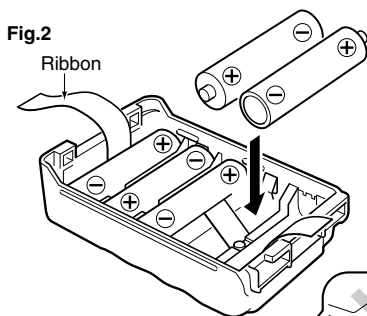
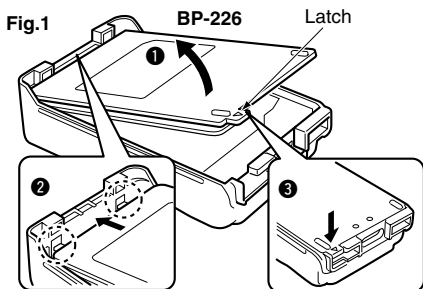

7 SPEAKER-MICROPHONE

■ Optional HM-138 description

Alligator type clip
To attach the speaker-mic.
to your shirt or collar, etc.

PTT switch
Transmits while pushed
Receives while released

Microphone

Speaker

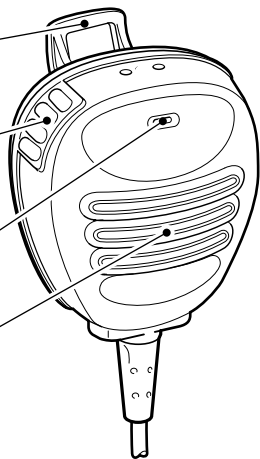

NEVER immerse the connector in water. If the connector becomes wet, be sure to dry it **BEFORE** attaching it to the transceiver.

NOTE: The microphone is located at the top of the speaker-microphone, as shown in the diagram above. To maximize the readability of your transmitted signal (voice), hold the microphone approx. 5 to 10 cm (2 to 4 inches) from your mouth, and speak in a normal voice level.

■ Attachment

Attach the connector of the speaker-microphone into the [SP MIC] connector on the transceiver and tighten the screw.

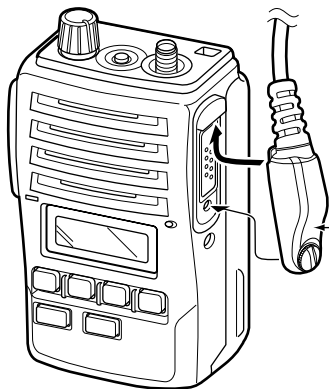

CAUTION: Attach the speaker-microphone's connector securely to prevent accidental dropping, or water intrusion in the connector.

IMPORTANT: KEEP the [SP MIC] jack cover attached (transceiver) when the speaker-microphone is not in use. Water will not get into the transceiver even if the cover is not attached, however, the terminals (pins) will become rusty, or the transceiver will function abnormally if the connector becomes wet.

8 OPTIONS

- **BP-226 BATTERY CASE**

Battery case for 5 × AA (R6) alkaline cells.

- **BP-227/FM Li-Ion BATTERY PACK**

7.2 V/1700 mAh Li-Ion battery pack. The same as supplied with the transceiver. BP-227/FM must be charged with the optional BC-152 or the BC-119N/121N. BP-227FM must be used for the intrinsically safe type.



BP-226



BP-227/FM*

*The serial seal content is different between the BP-227 and the BP-227FM.

- **BC-152 DESKTOP CHARGER + BC-147A/E AC ADAPTER**



Used for regular charging of the battery pack. The AC adapter, BC-147A/E, must be purchased separately.

Charging time: approx. 9–10 hours

- **BC-119N DESKTOP CHARGER + AD-100 CHARGER ADAPTER + BC-145 AC ADAPTER**



For rapid charging of battery packs. An AC adapter is not supplied with some versions.

Charging time: approx. 2 to 2.5 hours

- **BC-121N** MULTI-CHARGER + **AD-100** CHARGER ADAPTER (6 pcs.)
+ **BC-157** AC ADAPTER



For rapid charging of up to 6 battery packs (six AD-100's are required) simultaneously. An AC adapter should be purchased separately. Charging time: approx. 2 to 2.5 hours.

- **HM-138** SPEAKER-MICROPHONE



Full-sized waterproof (JIS grade 7; 1m/30 min.) speaker-microphone including alligator type clip to attach to your shirt or collar, etc.

- **OPC-966** INTERFACE CABLE

Provides advanced operation, such as printer, GPS connection for position data transmission capabilities during BIIS operation.

- **FA-S62VS/FA-S63VS/FA-S57US** STUBBY ANTENNAS

FA-S62VS: 150–162 MHz

FA-S63VS: 160–174 MHz

FA-S57US: 450–490 MHz

Some options may not available in some countries. Please ask your dealer for details.

Count on us!

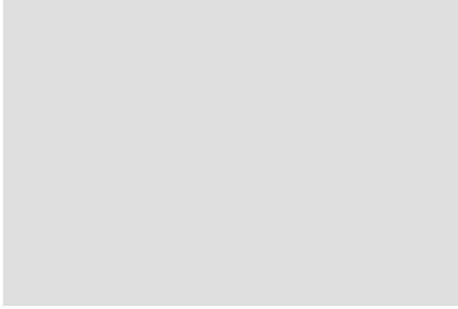

A-6533H-1EX
Printed in Japan
© 2006 Icom Inc.

Icom Inc.
1-1-32 Kamiminami, Hirano-ku, Osaka 547-0003, Japan
